

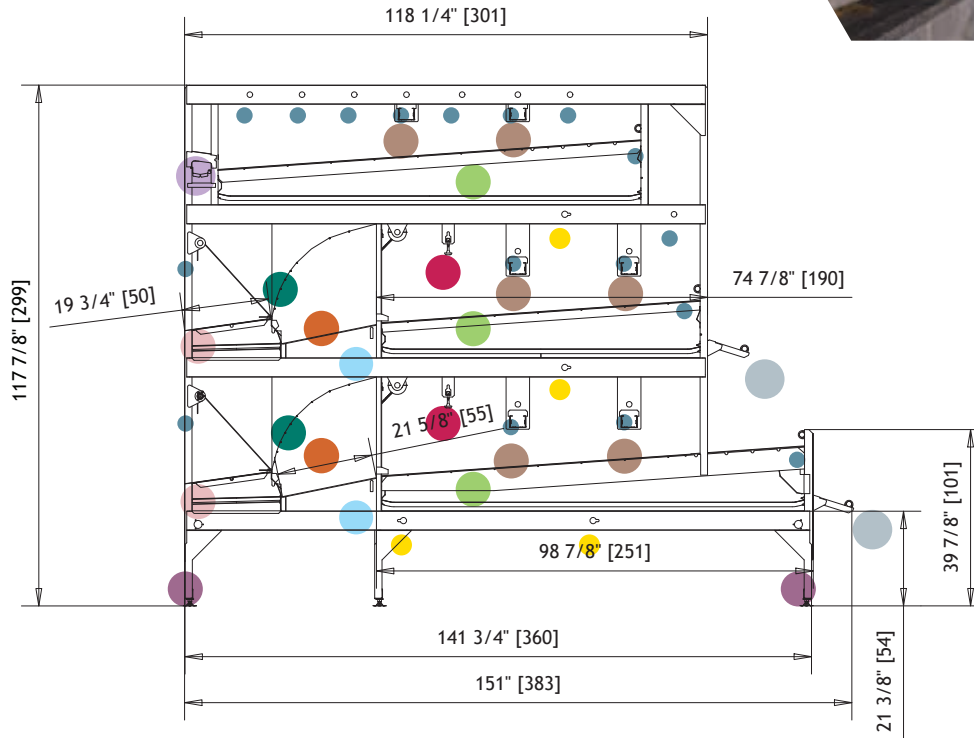









# AS LOGGIA

## Aviary System for Layers



3 PIANI  
3 TIERS



- |   |   |   |  |
|---|---|---|--|
|  | <b>Astroturf removibile e autopulente</b><br>Removable and self-cleaning astroturf  |  | <b>Sportello automatico/manuale</b><br>Automatic/manual door   |
|  | <b>Protezione nastro uova per maggior area utile</b><br>Protection cover over egg belt providing extra area                                   |  | <b>Apertura per ispezione nido centralizzata</b><br>Centralized opening for nest inspection                |
|  | <b>Mangiatoie dotate di profilo antispreco</b><br>Feed trough with anti-waste profile   |  | <b>Linea di abbeveraggio</b><br>Drinking line  |
|  | <b>Trespole mobile (può essere usato per l'ispezione)</b><br>Movable perch (can be used for inspection)                                       |  | <b>Bandina/Trespole protezione uova in acciaio inox</b><br>Egg protection profile/perch in stainless steel |
|  | <b>Nido con apertura automatica</b><br>Nest with automatic movement for ejection  |  | <b>Trespole</b><br>Perch   |
|  | <b>Piani inclinati per consentire alle uova esterne di convergere nel nido</b><br>Sloping floors to allow non nest eggs to roll into the nest |  | <b>Illuminazione a Led</b><br>Led lighting   |

### VANTAGGI

- > Estrema compattezza per massimizzare il numero di animali presenti nell'impianto con ottimale distribuzione di componenti
- > Sistema aperto studiato per avere un ottimale movimento degli animali ed elevare il livello di welfare
- > Facilità di ispezione per tutto il sistema grazie all'apertura posteriore del nido con movimentazione centralizzata
- > Nido con tappeto astroturf forato e pavimento mobile, per maggior pulizia
- > Copertura nastro uova con superficie utilizzabile
- > Larghezza del nastro delle uova aumentata per migliorare il trasporto delle uova
- > Progettato per agevolare l'operatore
- > Materiali ad elevata resistenza e qualità

### BENEFITS

- > Extremely compact design to maximize the number of birds in the barn with optimal distribution of accessories
- > Open system designed to have an optimal movement of birds to elevate the level of welfare
- > Easy inspection for the whole system thanks to the rear opening of the nest with centralized system
- > Nest with perforated astroturf & moving floor, for cleaner eggs
- > Egg belt cover countable as usable surface
- > Increased egg belt width to improve egg transport and reduce damage
- > Designed with the operator in mind
- > Materials with high quality corrosion resistance

# AS LOGGIA

Aviary System for Layers

2 PIANI  
2 TIERS

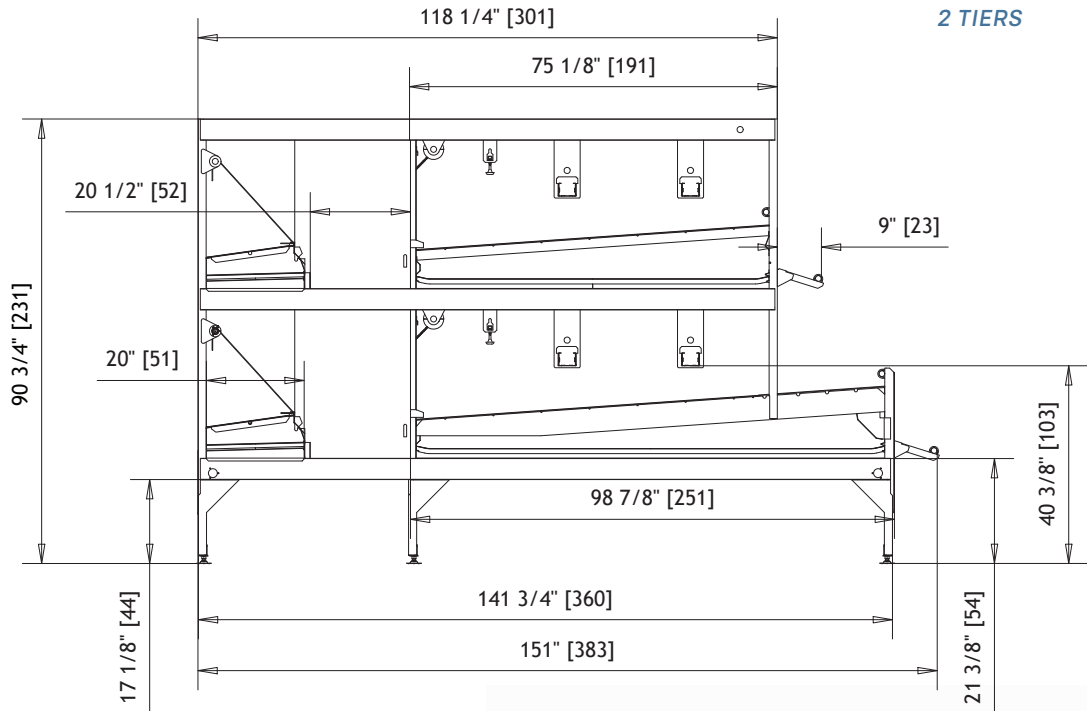

Scansiona il codice QR  
per scoprire di più.

Scan the QR code to  
find more.

Contatta il tuo referente Tecno o visita il nostro sito  
per maggiori informazioni.

Contact your Tecno representative or visit our  
website for more information.

[poultryequipment.com](http://poultryequipment.com)